

AM 320

CAPACITA' DI ADESCAMENTO / SUCTION CAPABILITY:

AM 320: La pompa standard è adescante da 1 metro * / *The standard pump is self priming from 1 meter **

Con aggiunta di SERBATOIO ** la pompa adessa da 3 metri in 2'30" (tubo di aspirazione Øint. 35mm o 32mm).* / *The TANK ** allows the pump to self prime from 3 meters in 2'30" (using a suction piping with inner Ø 35mm or 32mm)*.*

* Sul livello del mare-Prove effettuate con acqua./ *Above sea level. Tests carried out with water*

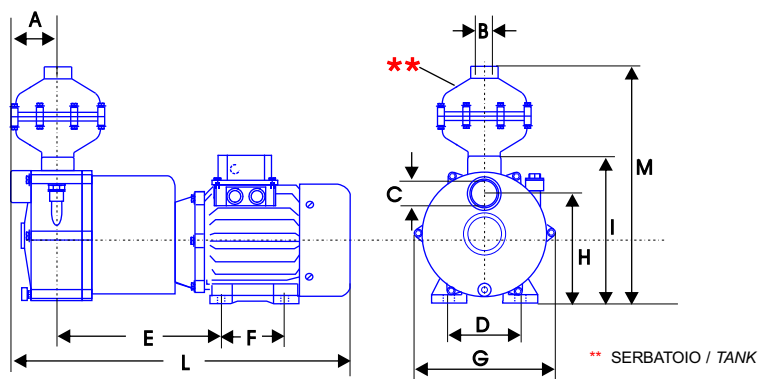
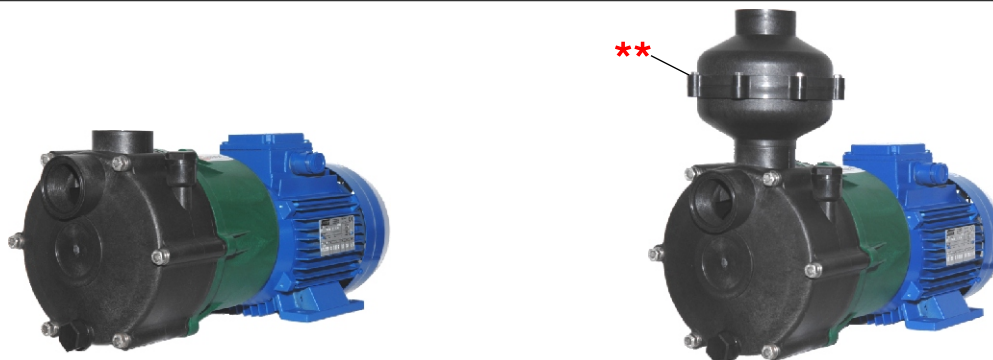

	Dimensioni/Dimensions										Motore/Motor				Peso/Weight	
	A	B	C	D	E	F	G	H	I	L	M	MEC	Flanginto/ Bracket	KW	PHASES	KG
AM 320	83	1"½	1"½	140	215	100	220	171	224	*490	362	90	B3-B14	1,5	3	**20,430

* Varia in rapporto al motore montato

** Varia in rapporto ai materiali e al motore montato (IE2)

I filetti indicati a disegno (B,C) sono FEMMINA.

* It changes according to the assembled motor

** It changes according to the materials and to the assembled motor (IE2)

The threads on the drawing (B,C) are FEMALE.

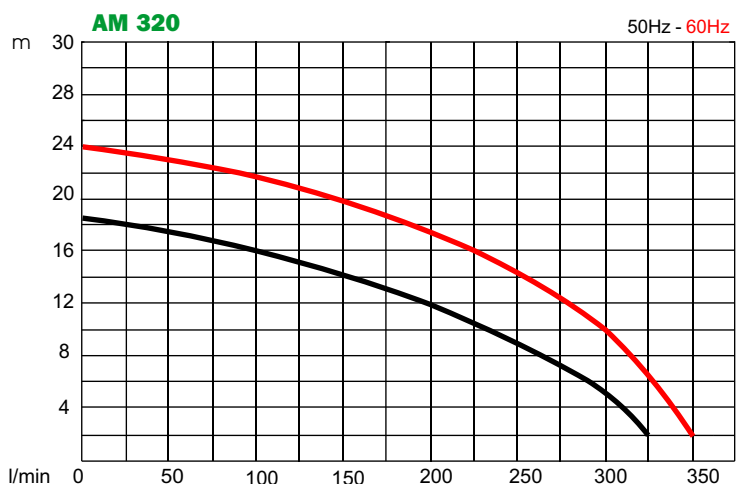

PESO SPECIFICO MAX: 1,2 / MAX SPECIFIC GRAVITY : 1,2

Riferimenti per le curve: acqua a temperatura ambiente / Curve references: water at room temperature



PLASTOMECC S.r.l. - Via F. Turati, 75 - 40014 CREVALCORE (BO) - ITALY
Tel. +39.051.981410 - Fax +39.051.981387

www.plastomec.com



AM 320

Costruzione / Construction :

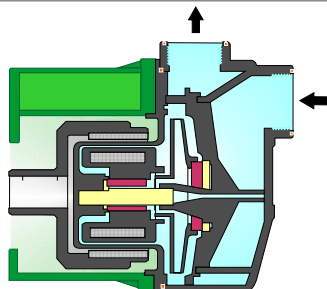

Materiali a contatto con il liquido /
Materials coming into contact with liquid:

* Altri materiali disponibili su richiesta /
Other materials upon request

PP (polipropilene F.V./polypropylene)	PVDF (polifluoruro di vinilidene/ polyvinylidene fluoride)
EPDM L'OR in EPDM è standard nella versione in PP. The O-Ring in EPDM is standard for the PP version.	FP L'OR in FP è standard nella versione in PVDF. The O-Ring in FP is standard for the PVDF version.
Ceramica alluminica/Alumel ceramic Al ₂ O ₃ 99,7% *	
Rulon® o/or PTFE C. *	

Le pompe con bocche in CARBONE HD possono accidentalmente girare a secco senza danneggiarsi.
The pumps supplied with CARBON H.D. bushings can accidentally run dry without suffering damage.

Temperature di utilizzo (valori testati con acqua)/
Operation temperatures (test carried out with water) :

PP	0°C - 80°C
PVDF	0°C - 90°C

ACCESSORI DISPONIBILI AVAILABLE ACCESSORIES

Flangiati
Flange connections

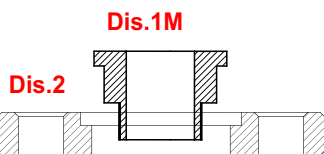

Codice / Code N°	ISO-DIN	Aspir./E Inlet	Mand./U Outlet	Dis.1M + Dis.2	
				Materiale Material	Materiale Material
8	DN 40	1" 1/2	1" 1/2	PP o PVDF	PP

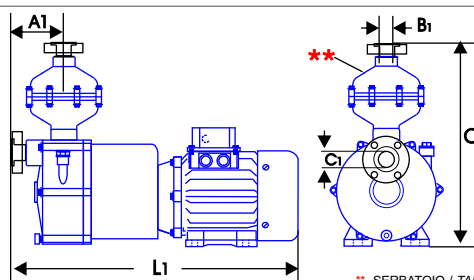

	ISO-DIN	A1	B1	C1	L1	O
AM 320	DN 40	110	Ø 38	Ø 38	*517	389

* Varia in rapporto al motore montato. It changes according to the assembled motor

Supporto motore
Motor bearing

TIPO 2
Type 2

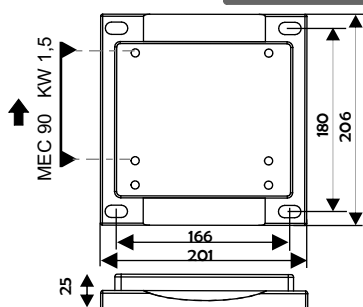

MOTORE MEC 90 Kw 1.5
Misura MEC B3: 140x100

MOTOR MEC 90 Kw 1.5
Size MEC B3: 140x100



Portagomma
Hose connections

Misura / Size	Aspir./E Inlet	Mand./U Outlet	Materiale Material
Ø 40	1" 1/2	1" 1/2	PP o PVDF

Serbatoio
Tank

☐ La pompa può essere fornita di **SERBATOIO ****, che facilita l'adescamento al momento della messa in funzione

☐ The pump can be supplied with **TANK **** that make easy the priming when start to work.



ATTENZIONE: leggere attentamente il MANUALE D'USO E MANUTENZIONE prima di installare e utilizzare la pompa
WARNING: read the OPERATION AND INSTRUCTIONS MANUAL carefully before installing and operating the pump

Per informazioni tecniche più dettagliate rivolgersi a PLASTOMECC s.r.l. / For any other technical specifications contact PLASTOMECC s.r.l.
I dati nel catalogo possono essere variati senza preavviso/We reserve the right to modify all the specifications written on this catalogue without any notice

